

Dimension Drawing - 500VA inverter GFCI

PIN125010510	Inverter 12/500 120V VE.Direct NEMA GFCI
PIN245010510	Inverter 24/500 120V VE.Direct NEMA GFCI
PIN485010510	Inverter 48/500 120V VE.Direct NEMA GFCI

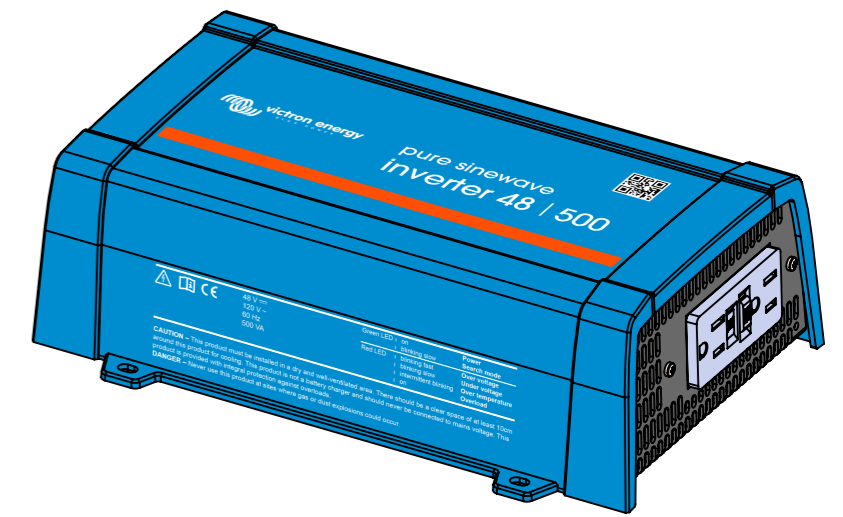

Dimensions in mm

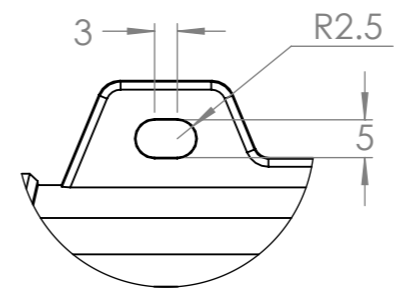
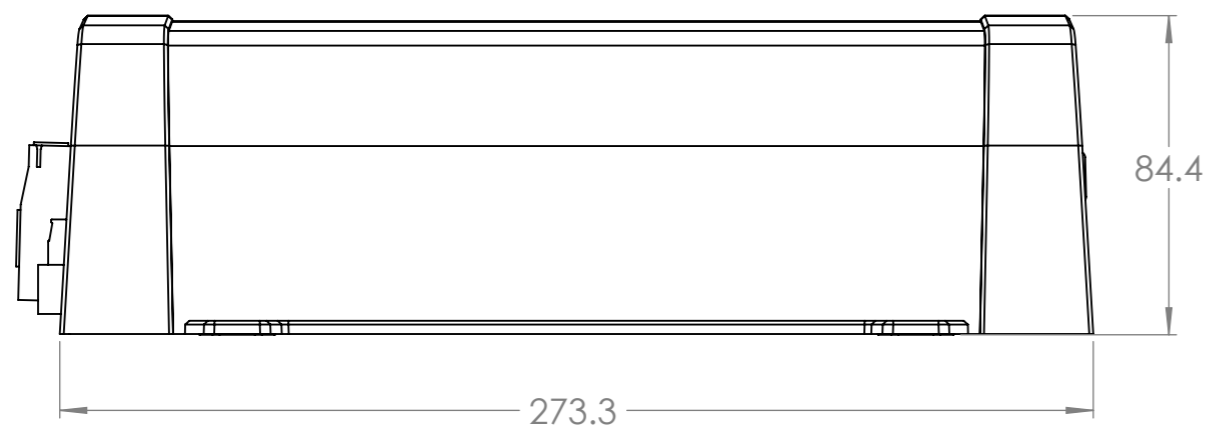
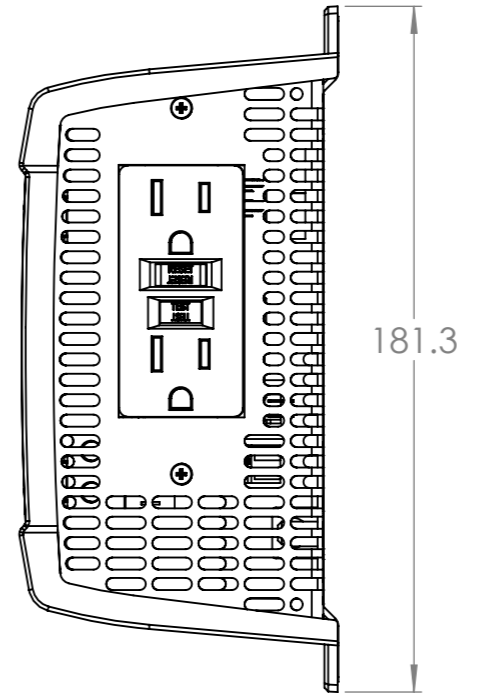
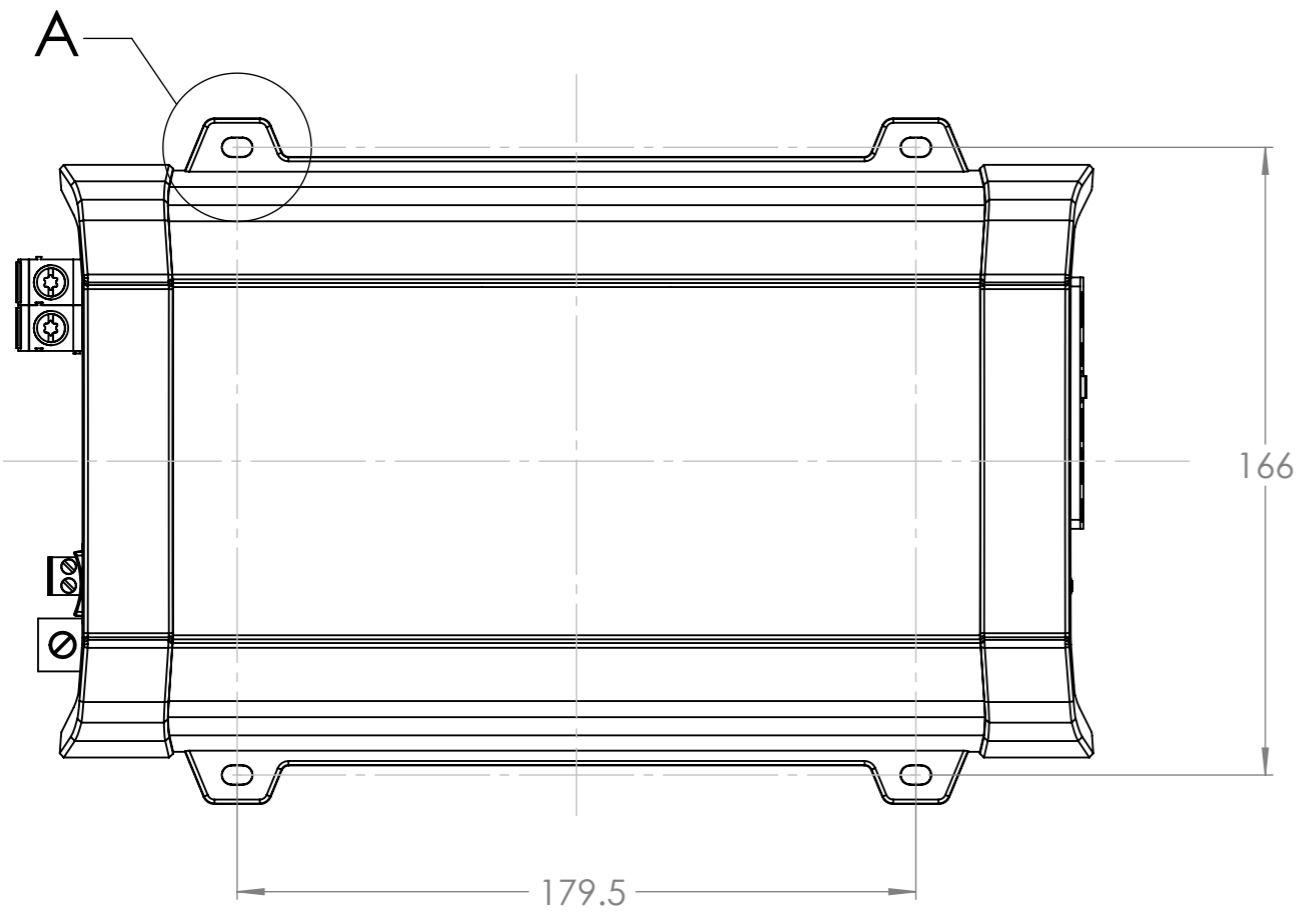